

RECORD OF SURVEY
 A PORTION OF THE NW 1/4 OF SECTION 2 AND
 A PORTION OF THE NE 1/4 OF SECTION 3
 TOWNSHIP 19 NORTH, RANGE 15 EAST, W.M.,
 KITTITAS COUNTY, WASHINGTON

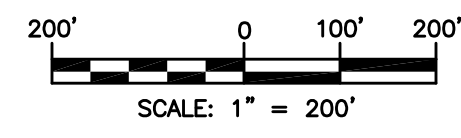

LEGEND

- CALCULATED SECTION CORNER, AS NOTED
- QUARTER CORNER, AS NOTED
- CALCULATED QUARTER CORNER, AS NOTED
- FOUND 5/8" REBAR & CAP, AS NOTED
- SET 5/8" REBAR & CAP, LS 45503



SURVEYOR'S CERTIFICATE

THIS MAP CORRECTLY REPRESENTS A SURVEY MADE BY ME OR UNDER MY DIRECTION IN CONFORMANCE WITH THE REQUIREMENTS OF THE SURVEY RECORDING ACT AT THE REQUEST OF BOB ROSEBURG IN AUG. 2021.

 DUSTIN L. PIERCE DATE
 CERTIFICATE NO. 45503

INDEX LOCATION		INDEX LOCATION	
SEC. 3 T. 19 N.R. 15 E.W.M.		SEC. 2 T. 19 N.R. 15 E.W.M.	
3	3	2	2

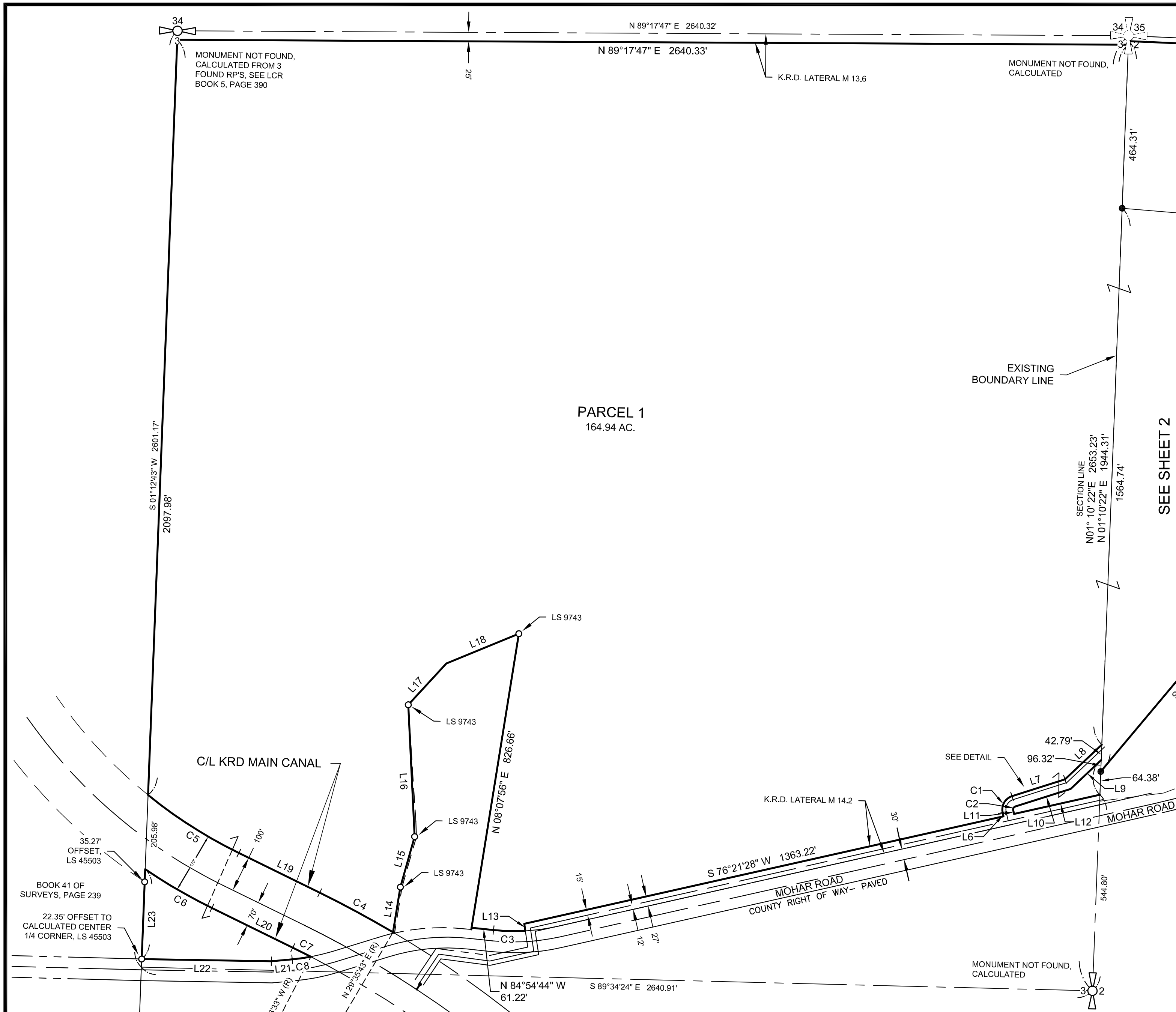

AUDITOR'S CERTIFICATE
 FILED FOR RECORD THIS ____ DAY OF ____ 20__ AT ____ M.
 IN BOOK ____ OF ____ AT PAGE ____ AT THE REQUEST OF

 DUSTIN L. PIERCE
 SURVEYOR'S NAME

 JERALD V. PETTIT
 County Auditor Deputy County Auditor

Encompass
 ENGINEERING & SURVEYING

Western Washington Division
 165 NE Juniper Street, Suite 201 • Issaquah, WA 98027 • Phone: (425) 392-0250
 Eastern Washington Division
 407 Swiftwater Blvd. • Cle Elum, WA 98922 • Phone: (509) 674-7433

BOUNDARY LINE ADJUSTMENT
 PREPARED FOR
 BOB ROSEBURG
 A PORTION OF THE NW 1/4 OF SECTION 2 & THE NE QUARTER OF SECTION 3,
 TOWNSHIP 19 NORTH, RANGE 15 EAST, W.M.
 KITTITAS COUNTY WASHINGTON

DWN BY	DATE	JOB NO.
DLP	8/2021	20186
CHKD BY	SCALE	SHEET
GW	1" = 200'	1 OF 3

BOOK 41 OF SURVEYS, PAGE 239
 22.35' OFFSET TO CALCULATED CENTER 1/4 CORNER, LS 45503
 35.27' OFFSET, LS 45503
 FOUND 1 1/2" ALUM. CAP ON REBAR, LS 9606, SEE LCR BOOK 4, PAGES 179-180

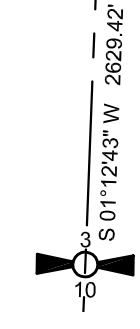

RECORD OF SURVEY

A PORTION OF THE NW 1/4 OF SECTION 2 AND A PORTION OF THE NE 1/4 OF SECTION 3
TOWNSHIP 19 NORTH, RANGE 15 EAST, W.M.,
KITITAS COUNTY, WASHINGTON

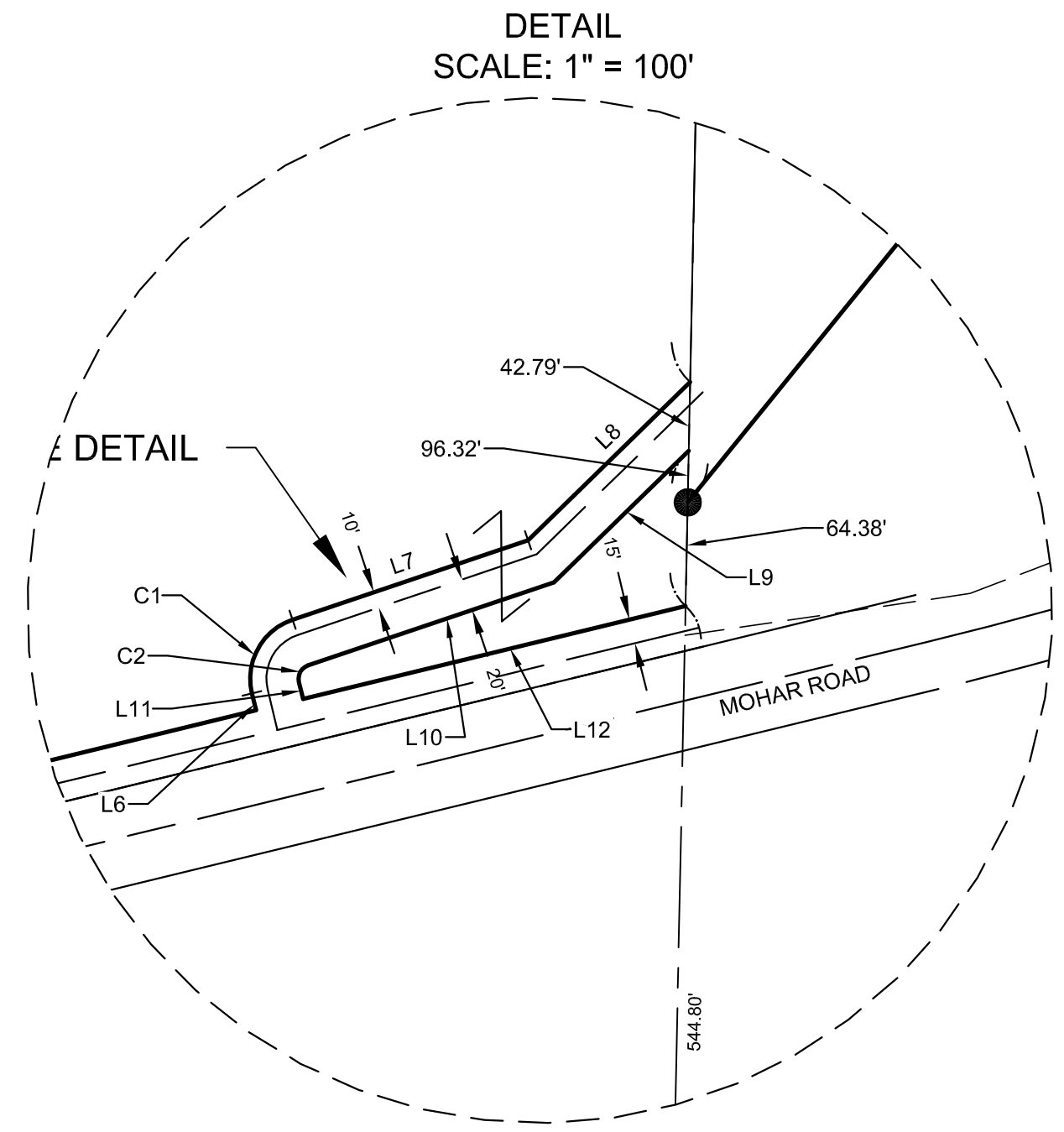
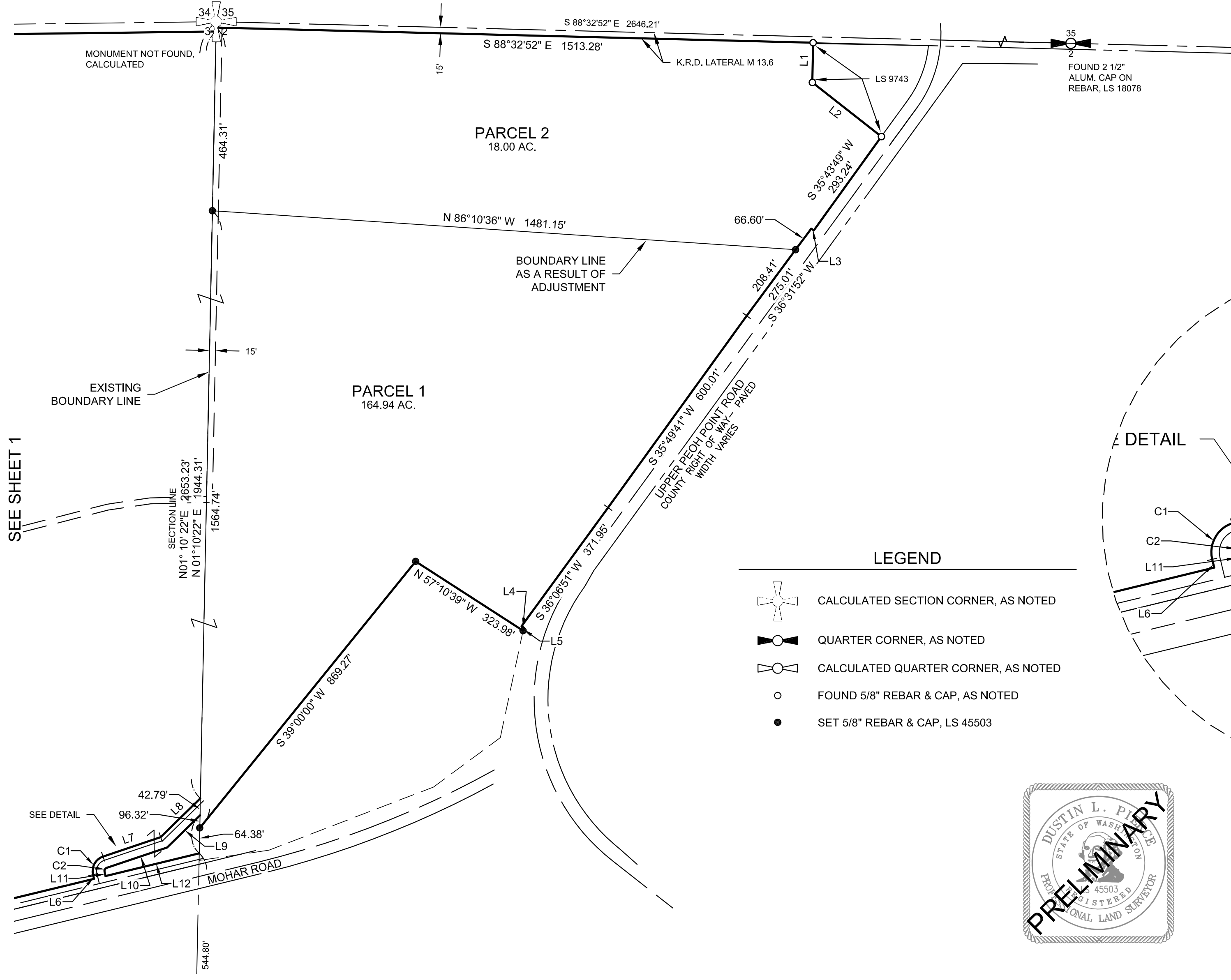
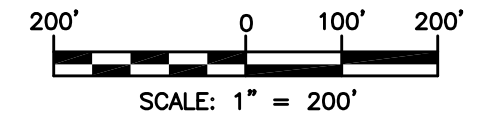

LEGEND

- CALCULATED SECTION CORNER, AS NOTED
- QUARTER CORNER, AS NOTED
- CALCULATED QUARTER CORNER, AS NOTED
- FOUND 5/8" REBAR & CAP, AS NOTED
- SET 5/8" REBAR & CAP, LS 45503

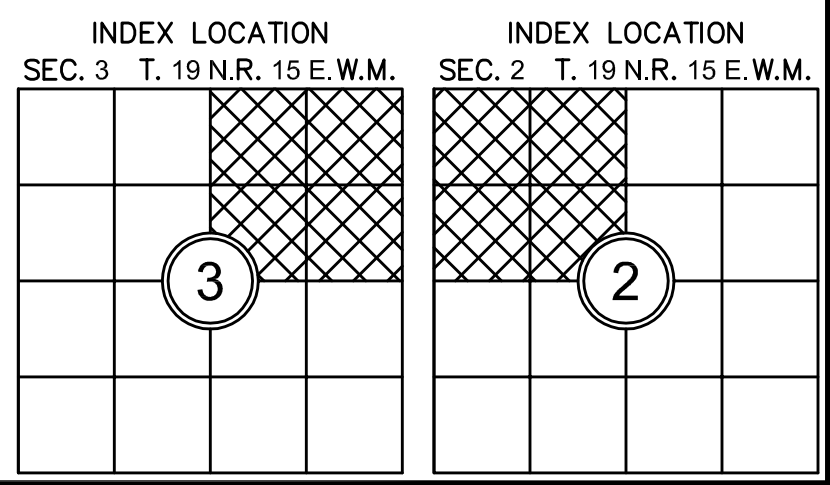

SEE SHEET 1

SEE SHEET 1

AUDITOR'S CERTIFICATE _____
 FILED FOR RECORD THIS ____ DAY OF ____ 20__ AT ____ M.
 IN BOOK ____ OF ____ AT PAGE ____ AT THE REQUEST OF

 DUSTIN L. PIERCE
 SURVEYOR'S NAME

 JERALD V. PETTIT
 County Auditor Deputy County Auditor

Encompass

ENGINEERING & SURVEYING

Western Washington Division
 165 NE Juniper Street, Suite 201 • Issaquah, WA 98027 • Phone: (425) 392-0250
 Eastern Washington Division
 407 Swiftwater Blvd. • Cle Elum, WA 98922 • Phone: (509) 674-7433

BOUNDARY LINE ADJUSTMENT		
PREPARED FOR BOB ROSEBURG		
A PORTION OF THE NW 1/4 OF SECTION 2 & THE NE QUARTER OF SECTION 3, TOWNSHIP 19 NORTH, RANGE 15 EAST, W.M.		
KITITAS COUNTY		WASHINGTON
DWN BY	DATE	JOB NO.
DLP	8/2021	20186
CHKD BY	SCALE	SHEET
GW	1" = 200'	2 OF 3

RECORD OF SURVEY
A PORTION OF THE NW 1/4 OF SECTION 2 AND A PORTION OF THE NE 1/4 OF SECTION 3
TOWNSHIP 19 NORTH, RANGE 15 EAST, W.M.,
KITTITAS COUNTY, WASHINGTON



EXISTING LEGAL DESCRIPTIONS PER CHICAGO TITLE INSURANCE COMPANY GUARANTEE NO. 72156-47372029

TRACT A:

THAT PORTION OF THE NORTHWEST QUARTER OF SECTION 2, TOWNSHIP 19 NORTH, RANGE 15 EAST, W.M., KITTITAS COUNTY, STATE OF WASHINGTON DESCRIBED AS FOLLOWS: BEGINNING AT THE NORTHWEST CORNER OF SAID NORTHWEST QUARTER; THENCE RUNNING SOUTH ALONG THE WEST LINE OF SAID NORTHWEST QUARTER TO A POINT 669.18 FEET NORTH OF THE SOUTHWEST CORNER OF SAID NORTHWEST QUARTER; THENCE NORTH 39° EAST, 858 FEET; THENCE SOUTH 57°30' EAST, 338.58 FEET; THENCE NORTH 35° EAST TO THE NORTH LINE OF SAID NORTHWEST QUARTER; THENCE WEST ALONG SAID NORTH LINE TO THE POINT OF BEGINNING;

EXCEPT:

- THE NORTH 15 FEET, THEREOF, CONVEYED TO THE KITTITAS RECLAMATION DISTRICT BY WARRANTY DEED RECORDED MAY 31, 1929, UNDER AUDITOR'S FILE NO. 95571;
- THAT PORTION OF THE NORTHWEST QUARTER OF SECTION 2, TOWNSHIP 19 NORTH, RANGE 15 EAST, W.M., ALL SITUATED IN KITTITAS COUNTY, STATE OF WASHINGTON MORE PARTICULARLY DESCRIBED AS FOLLOWS: BEGINNING AT A 5/8" DIA. REBAR, 20" IN LENGTH WITH AN ORANGE PLASTIC CAP MARKED BAILEY, PLS 9743 DRIVEN FLUSH WITH THE GROUND AT THE INTERSECTION OF THE SOUTH EDGE OF THE KITTITAS RECLAMATION DISTRICT RIGHT-OF-WAY AND THE WESTERLY EDGE OF THE RIGHT-OF-WAY FOR THE UPPER PEOH POINT COUNTY ROAD, SAID REBAR BEING THE TRUE POINT OF BEGINNING; THENCE NORTH 88°55'35" WEST ALONG THE SOUTH EDGES OF SAID KRD RIGHT OF WAY, 292.53' TO A 5/8" DIA. REBAR IDENTICAL TO THE FIRST MENTIONED REBAR; THENCE SOUTH 01°04'25" WEST AT RIGHT ANGLES TO SAID SOUTH EDGE OF THE KRD RIGHT OF WAY, 98.87' TO A 5/8" DIA. REBAR IDENTICAL TO THE FIRST MENTIONED REBAR; THENCE SOUTH 51°54'58" EAST, 222.13' TO THE INTERSECTION WITH THE WESTERLY EDGE OF SAID COUNTY ROAD RIGHT OF WAY MARKED WITH A 5/8" DIA. REBAR IDENTICAL TO THE FIRST MENTIONED REBAR; THENCE NORTH 36°05'51" EAST ALONG THE WESTERLY EDGE OF SAID COUNTY ROAD RIGHT OF WAY 112.22' TO A 5/8" DIA. REBAR IDENTICAL TO THE FIRST MENTIONED REBAR WHICH MARKS THE BEGINNING OF A CURVE; THENCE CONTINUING ON THE CURVE TO THE LEFT WITH A RADIUS OF 285.41' A DELTA OF 30°22'38" FOR 151.32' TO THE TRUE POINT OF BEGINNING.
- A PARCEL OF LAND IN THE NORTH HALF OF THE NORTHWEST QUARTER, SECTION 2, TOWNSHIP 19 NORTH, RANGE 15 EAST, W.M., LAYING WESTERLY OF UPPER PEOH POINT ROAD, RECORDED AT KITTITAS COUNTY AUDITOR'S OFFICE FILE NO. 240836, BOOK 92, PAGE 541; COMMENCING AT ENGINEER STATION 34+75; THENCE NORTH 53°53'55" WEST TO THE TRUE POINT OF BEGINNING, SAID POINT BEING PERPENDICULAR OR RADIAL TO CENTERLINE; THENCE NORTH 53°53'55" WEST, 8.18 FEET; THENCE SOUTH 36°31'05" WEST, 275.01 FEET; THENCE SOUTH 35°48'54" WEST, 600.01 FEET; THENCE SOUTH 36°06'05" WEST, 372.04 FEET; THENCE SOUTH 57°30'00" EAST, 6.74 FEET; THENCE NORTH 35°32'38" EAST, 176.69 FEET; THENCE NORTH 36°13'04" EAST, 1,069.93 FEET TO THE TRUE POINT OF BEGINNING.
- THAT PORTION, IF ANY, LYING WITHIN THE RIGHT OF WAY OF COUNTY ROADS KNOWN AS UPPER PEOH POINT ROAD AND MOHAR ROAD.

TRACT B:

THE NORTHEAST QUARTER OF SECTION 3, TOWNSHIP 19 NORTH, RANGE 15 EAST, W.M., IN THE COUNTY OF KITTITAS, STATE OF WASHINGTON; EXCEPT:

- RIGHT-OF-WAY FOR MOHAR COUNTY ROAD;
- A TRACT OF LAND WITHIN THE SOUTHWEST QUARTER OF THE NORTHEAST QUARTER OF SECTION THREE (3), BEING 170 FEET IN WIDTH, HERETOFORE CONVEYED BY BRITTA JUSTIN ROSEBURG AND WILLIAM REES TO THE KITTITAS RECLAMATION DISTRICT BY DEED DATED JUNE 23, 1926, FILED FOR RECORD JULY 3, 1926, AND RECORDED IN BOOK 43 OF DEEDS, PAGE 470;
- FIVE TRACTS OF LAND WITHIN THE ABOVE DESCRIBED LANDS BEING OF VARIOUS WIDTHS AS CONVEYED BY BRITTA JUSTIN ROSEBURG AND WILLIAM REES TO THE KITTITAS RECLAMATION DISTRICT BY DEED DATED MAY 21, 1929, FILED FOR RECORD MAY 31, 1929, AND RECORDED IN BOOK 47 OF DEEDS, PAGE 381;
- THAT PORTION OF THE NORTHEAST QUARTER OF SAID SECTION 3 WHICH LIES SOUTH OF THE COUNTY ROAD RUNNING BETWEEN CLE ELUM AND EASTON;
- THAT PORTION OF THE SOUTHWEST QUARTER OF THE NORTHEAST QUARTER OF SAID SECTION 3, MORE PARTICULARLY DESCRIBED AS FOLLOWS:

BEGINNING AT THE NORTHEAST CORNER OF SAID SECTION 3; THENCE SOUTH 01°06'22" WEST ALONG THE EAST LINE OF SAID SECTION 2, 199.42 FEET TO INTERSECT WITH THE SOUTH EDGE OF THE RIGHT-OF-WAY FOR MOHAR ROAD; THENCE SOUTH 76°21'10" WEST ALONG THE SOUTH EDGE OF SAID RIGHT-OF-WAY EXTENDED 1,842.73 FEET TO AN IRON PIN; THENCE NORTH 74°21'04" WEST, 218.86 FEET TO THE CENTERLINE OF MOHAR ROAD AT THE EAST END OF THE BRIDGE OVER THE KRD CANAL; THENCE NORTH 18°17'15" WEST, 30.00 FEET TO THE NORTH EDGE OF THE RIGHT-OF-WAY FOR MOHAR ROAD; THENCE NORTH 71°42'45" EAST ALONG THE NORTH EDGE OF SAID RIGHT-OF-WAY 20.34 FEET; THENCE CONTINUING ALONG THE NORTH EDGE OF SAID RIGHT-OF-WAY 42.98 FEET ON A CURVE TO THE RIGHT WHICH HAS A RADIUS OF 602.96 FEET TO THE TRUE POINT OF BEGINNING;

THENCE NORTH 08°07'22" EAST, 130.33 FEET; THENCE NORTH 14°58'24" EAST, 145.41 FEET;

THENCE NORTH 03°09'35" WEST, 42.26 FEET; THENCE NORTH 04°42'36" WEST, 324.82 FEET; THENCE NORTH 41°41'09" EAST, 155.78 FEET; THENCE NORTH 66°38'08" EAST, 217.60 FEET; THENCE SOUTH 08°07'22" WEST, 831.67 FEET TO THE NORTH EDGE OF THE RIGHT-OF-WAY FOR MOHAR ROAD;

THENCE NORTH 85°13'15" WEST ALONG SAID RIGHT-OF-WAY EDGE 19.37 FEET; THENCE CONTINUING ALONG THE NORTH EDGE OF SAID RIGHT-OF-WAY 199.78 FEET ON A CURVE TO THE LEFT WHICH HAS A RADIUS OF 602.96 FEET TO THE TRUE POINT OF BEGINNING.

DESCRIPTIONS AS A RESULT OF ADJUSTMENT:

PARCEL 1

THE NORTHEAST QUARTER OF SECTION 3, TOWNSHIP 19 NORTH, RANGE 15 EAST, W.M., IN THE COUNTY OF KITTITAS, STATE OF WASHINGTON; EXCEPT:

- RIGHT-OF-WAY FOR MOHAR COUNTY ROAD;
- A TRACT OF LAND WITHIN THE SOUTHWEST QUARTER OF THE NORTHEAST QUARTER OF SECTION THREE (3), BEING 170 FEET IN WIDTH, HERETOFORE CONVEYED BY BRITTA JUSTIN ROSEBURG AND WILLIAM REES TO THE KITTITAS RECLAMATION DISTRICT BY DEED DATED JUNE 23, 1926, FILED FOR RECORD JULY 3, 1926, AND RECORDED IN BOOK 43 OF DEEDS, PAGE 470;
- FIVE TRACTS OF LAND WITHIN THE ABOVE DESCRIBED LANDS BEING OF VARIOUS WIDTHS AS CONVEYED BY BRITTA JUSTIN ROSEBURG AND WILLIAM REES TO THE KITTITAS RECLAMATION DISTRICT BY DEED DATED MAY 21, 1929, FILED FOR RECORD MAY 31, 1929, AND RECORDED IN BOOK 47 OF DEEDS, PAGE 381;
- THAT PORTION OF THE NORTHEAST QUARTER OF SAID SECTION 3 WHICH LIES SOUTH OF THE COUNTY ROAD RUNNING BETWEEN CLE ELUM AND EASTON;
- THAT PORTION OF THE SOUTHWEST QUARTER OF THE NORTHEAST QUARTER OF SAID SECTION 3, MORE PARTICULARLY DESCRIBED AS FOLLOWS:

BEGINNING AT THE NORTHEAST CORNER OF SAID SECTION 3; THENCE SOUTH 01°06'22" WEST ALONG THE EAST LINE OF SAID SECTION 2, 199.42 FEET TO INTERSECT WITH THE SOUTH EDGE OF THE RIGHT-OF-WAY FOR MOHAR ROAD; THENCE SOUTH 76°21'10" WEST ALONG THE SOUTH EDGE OF SAID RIGHT-OF-WAY EXTENDED 1,842.73 FEET TO AN IRON PIN; THENCE NORTH 74°21'04" WEST, 218.86 FEET TO THE CENTERLINE OF MOHAR ROAD AT THE EAST END OF THE BRIDGE OVER THE KRD CANAL; THENCE NORTH 18°17'15" WEST, 30.00 FEET TO THE NORTH EDGE OF THE RIGHT-OF-WAY FOR MOHAR ROAD; THENCE NORTH 71°42'45" EAST ALONG THE NORTH EDGE OF SAID RIGHT-OF-WAY 20.34 FEET, THENCE CONTINUING ALONG THE NORTH EDGE OF SAID RIGHT-OF-WAY 42.98 FEET ON A CURVE TO THE RIGHT WHICH HAS A RADIUS OF 602.96 FEET TO THE TRUE POINT OF BEGINNING;

THENCE NORTH 08°07'22" EAST, 130.33 FEET; THENCE NORTH 14°58'24" EAST, 145.41 FEET;

THENCE NORTH 03°09'35" WEST, 42.26 FEET; THENCE NORTH 04°42'36" WEST, 324.82 FEET; THENCE NORTH 41°41'09" EAST, 155.78 FEET; THENCE NORTH 66°38'08" EAST, 217.60 FEET; THENCE SOUTH 08°07'22" WEST, 831.67 FEET TO THE NORTH EDGE OF THE RIGHT-OF-WAY FOR MOHAR ROAD;

THENCE NORTH 85°13'15" WEST ALONG SAID RIGHT-OF-WAY EDGE 19.37 FEET; THENCE CONTINUING ALONG THE NORTH EDGE OF SAID RIGHT-OF-WAY 199.78 FEET ON A CURVE TO THE LEFT WHICH HAS A RADIUS OF 602.96 FEET TO THE TRUE POINT OF BEGINNING.

TOGETHER WITH ALL THAT PORTION OF SECTION 2, TOWNSHIP 19 NORTH, RANGE 15 EAST, W.M., KITTITAS COUNTY, STATE OF WASHINGTON.

BEING MORE PARTICULARLY DESCRIBED AS FOLLOWS:

COMMENCING AT THE NORTHWEST CORNER OF SAID NORTHWEST QUARTER OF SAID SECTION 2;

- THENCE SOUTH 01°10'22" WEST, ALONG THE WEST BOUNDARY OF SAID NORTHWEST QUARTER, 479.31 FEET TO THE TRUE POINT OF BEGINNING;
- THENCE SOUTH 86°10'36" EAST, 1481.15 FEET TO THE WEST BOUNDARY OF UPPER PEOH POINT COUNTY ROAD;
- THENCE SOUTH 36°31'52" WEST, ALONG SAID WEST BOUNDARY OF SAID COUNTY ROAD, 208.41 FEET;
- THENCE SOUTH 35°49'41" WEST, 600.01 FEET;
- THENCE SOUTH 36°06'51" WEST, 371.95 FEET;
- THENCE SOUTH 57°30'00" EAST, 6.60 FEET;
- THENCE SOUTH 12°00'00" WEST, 7.92 FEET;
- THENCE NORTH 57°10'39" WEST, 323.98 FEET;
- THENCE SOUTH 39°00'00" WEST, 869.27 FEET TO SAID WEST BOUNDARY OF SAID NORTHWEST QUARTER OF SAID SECTION 2;
- THENCE NORTH 01°10'22" EAST, ALONG SAID WEST BOUNDARY OF SAID NORTHWEST QUARTER, 1564.74 FEET TO THE TRUE POINT OF BEGINNING.

PARCEL 2:

ALL THAT PORTION OF THE NORTHWEST QUARTER OF SECTION 2, TOWNSHIP 19 NORTH, RANGE 15 EAST, W.M., KITTITAS COUNTY, STATE OF WASHINGTON, BEING MORE PARTICULARLY DESCRIBED AS FOLLOWS:

COMMENCING AT THE NORTHWEST CORNER OF SAID NORTHWEST QUARTER OF SAID SECTION 2;

- THENCE SOUTH 01°10'22" WEST, ALONG THE WEST BOUNDARY OF SAID NORTHWEST QUARTER, 15.00 FEET TO THE TRUE POINT OF BEGINNING;
- THENCE SOUTH 88°32'52" EAST 1513.28 FEET;
- THENCE SOUTH 01°05'26" WEST, 100.71 FEET;
- THENCE SOUTH 51°53'57" EAST, 222.34 FEET TO THE WESTERLY BOUNDARY OF UPPER PEOH POINT ROAD;
- THENCE SOUTH 35°43'49" WEST, ALONG SAID UPPER PEOH POINT ROAD, 293.24 FEET;
- THENCE NORTH 53°53'08" WEST, 8.18 FEET;
- THENCE SOUTH 36°31'52" WEST, 66.60 FEET;
- THENCE NORTH 86°10'36" WEST, 1481.15 FEET TO SAID WEST BOUNDARY OF SAID NORTHWEST QUARTER OF SAID SECTION 2;
- THENCE NORTH 01°10'22" EAST, ALONG SAID WEST BOUNDARY OF SAID NORTHWEST QUARTER, 464.31 FEET TO THE TRUE POINT OF BEGINNING.

LINE TABLE		
LINE #	DIRECTION	DISTANCE
L1	S 1°05'26" W	100.70'
L2	S 51°53'57" E	222.34'
L3	N 53°53'08" W	8.18'
L4	S 57°30'00" E	6.60'
L5	S 12°00'00" W	7.92'
L6	N 13°38'32" W	10.80'
L7	N 71°21'28" E	154.22'
L8	N 45°41'28" E	140.55'
L9	N 45°41'28" E	116.88'
L10	N 71°21'28" E	161.06'
L11	N 13°38'32" W	10.80'
L12	N 76°21'28" E	244.29'

LINE TABLE		
LINE #	DIRECTION	DISTANCE
L13	N 9°21'32" W	19.78'
L14	N 8°13'15" E	126.94'
L15	N 14°46'18" E	145.60'
L16	N 3°45'43" W	366.54'
L17	N 41°41'43" E	155.78'
L18	N 66°38'42" E	217.60'
L19	S 64°52'31" E	250.10'
L20	S 64°52'31" E	250.10'
L21	S 83°51'16" W	58.12'
L22	N 89°57'42" E	359.98'
L23	S 1°12'43" W	249.75'

CURVE TABLE			
CURVE #	RADIUS	LENGTH	DELTA
C1	38.70'	57.41'	85°00'00"
C2	8.70'	12.91'	85°00'00"
C3	542.96'	88.48'	9°20'14"
C4	2965.00'	231.34'	4°28'14"
C5	1332.50'	299.79'	12°53'27"
C6	1502.50'	214.51'	8°10'48"
C7	2795.00'	56.15'	1°09'04"
C8	542.96'	52.26'	5°30'54"

NOTES:

- THE PURPOSE OF THIS SURVEY IS TO ILLUSTRATE AND DELINEATE THE PARCELS, AS SHOWN HEREON, AND TO FACILITATE THE SATISFYING THE CONDITIONS FOR APPROVAL FOR AN APPLICATION FOR A BOUNDARY LINE ADJUSTMENT SUBMITTED SEPARATELY TO KITTITAS COUNTY UNDER APPLICATION NUMBER BL-21-00013.
- THIS SURVEY WAS PERFORMED USING A TRIMBLE S7, 3" TOTAL STATION AND A TRIMBLE R10 GNSS WITH ACCURACY THAT MEETS OR EXCEEDS WAC 332-130-090.
- THIS SURVEY DOES NOT PURPORT TO SHOW AL EASEMENTS, ENCUMBRANCES OR RESTRICTION OF RECORD OR OTHERWISE.
- FOR ADDITIONAL SURVEY AND REFERENCE INFORMATION, SEE THE FOLLOWING:
 - BOOK 22 OF SURVEYS, PAGE 138, AFN: 199701030023
 - BOOK 41 OF SURVEYS, PAGE 239, AFN: 201901180038
 - BOOK 31 OF SURVEYS, PAGE 62, AFN: 200504250061
AND THE SURVEYS REFERENCED THEREON. ALL RECORDS OF KITTITAS COUNTY, STATE OF WASHINGTON.
- BEARINGS ON THIS SURVEY ARE ON THE WASHINGTON STATE PLANE COORDINATE SYSTEM, NAD 83 (2011) EPOCH 2010, SOUTH ZONE, DERIVED FROM RTK GPS OBSERVATIONS USING THE FOLLOWING NGS STATION:

STATION DESIGNATION	PID	LATITUDE	LONGITUDE
0071 1993	AA5963	N 47° 10' 47.85133"	W 120° 56' 09.28094"

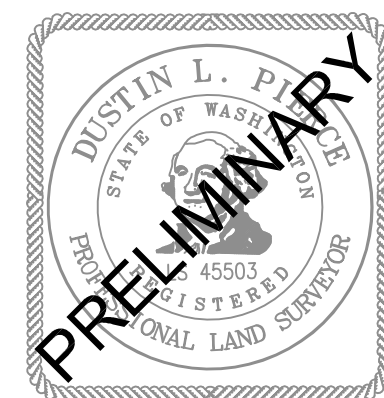

AUDITOR'S CERTIFICATE _____

FILED FOR RECORD THIS ____ DAY OF ____ 20__ AT ____ M.

IN BOOK ____ OF _____ AT PAGE ____ AT THE REQUEST OF _____

DUSTIN L. PIERCE
SURVEYOR'S NAME

JERALD V. PETTIT
County Auditor

Deputy County Auditor

Encompass
ENGINEERING & SURVEYING

Western Washington Division
165 NE Juniper Street, Suite 201 • Issaquah, WA 98027 • Phone: (425) 392-0250

Eastern Washington Division
407 Swiftwater Blvd. • Cle Elum, WA 98922 • Phone: (509) 674-7433

BOUNDARY LINE ADJUSTMENT
PREPARED FOR
BOB ROSEBURG

A PORTION OF THE NW 1/4 OF SECTION 2 & THE NE QUARTER OF SECTION 3,
TOWNSHIP 19 NORTH, RANGE 15 EAST, W.M.

KITTITAS COUNTY WASHINGTON

DWN BY	DATE	JOB NO.
DLP	8/2021	20186
CHKD BY	SCALE	SHEET
GW	N/A	3 OF 3